

# KH 400



## HIDROLİK TIP ENGELLİ PLATFORMU

HYDRAULIC TYPE DISABLED PLATFORM

Modern mimariye uyum sağlayan şık tasarımıyla KH400, engelli bireyler ve hareket kısıtlılığı olan kullanıcılar için özel olarak geliştirilmiş bir hidrolik tip engelli platformudur.

*With its modern design that adapts to modern architecture, the KH400 is a hydraulic-type disabled platform specifically designed for individuals with disabilities and users with limited mobility.*

İç mekan kurulumlarına uygun yapısıyla, yaşam alanlarında özgürlük sunar.

*With its structure suitable for indoor installation, it offers comfort in living spaces.*



Cam kaplama ile şeffaflık, zarafet ve güvenliği bir arada keşfedin.  
*Discover transparency, elegance and safety combined with glass cladding.*

Detaylı  
Ürün Bilgisi için  
Dokunun  
*Touch for  
Detailed Product  
Information*





# GÜVENLİĞİ ARTTIRIN, KONTROLÜ ELİNİZDE TUTUN!

INCREASE SECURITY AND  
KEEP CONTROL!

Şifre matik, asansörünüze sadece tanımlı kullanıcıların erişimine  
olanak sağlar.  
*Password matik allows only defined users to access your elevator.*

KH 400



KH 400

## KIMLER IÇIN IDEAL?

IDEAL FOR  
WHOM?

Asansör uygulanamayan ve bina statığının yetersiz olduğu alanlarda, platform liftler ile % 100 çözüm üretilir. Bina girişleri, kamu kurumları ve villalarda yaşlılar veya hareketi kısıtlı kullanıcılar için güvenli bir çözüm sunar. Yüksek yatırım bütçesi gerektirmeyen, sade ve güvenilir bir sistem arayanlar için idealdir.

*In areas where elevators cannot be applied and building statics are insufficient, 100% solution is produced with platform lifts. It enable a safe solution for the old or users with limited mobility in building entrances, public institutions and villas. It is ideal for those looking for a simple and reliable system that does not require a high investment budget.*

### KONSTRÜKSİYON RENGİ CONSTRUCTION COLOR



## KH 400 Teknik Özellikler Technical Features

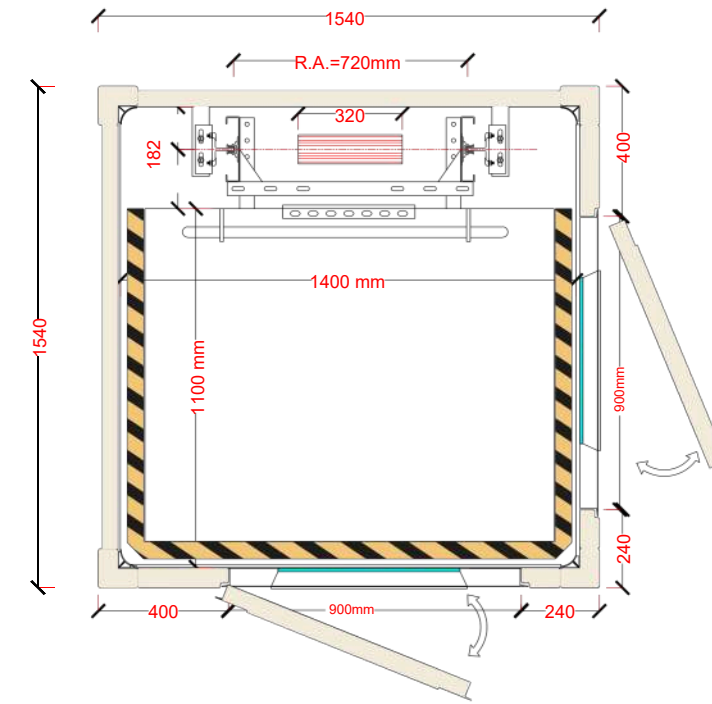

Sistem /System  
Hidrolik /Hydraulic

Hız /Speed  
Max. 0,15 m/s

Taşıma Kapasitesi /Carrying Capacity  
385 Kg

Durak Sayısı /Stops  
Max. 5 Durak /Max. 5 Stops

Max Seyir Mesafesi /Max Travel Distance  
13000mm

Çelik Konstrüksiyon Ölçüsü /Construction External Dimension  
1540x1540mm

Kullanım Yeri /Place of Use  
Dış - İç Mekan /Outdoor-Indoor

Platform Ölçüsü /Platform Dimension  
1100x1400mm

Kapı Ölçüsü /Door Dimension  
900x2000mm

Kapı Açma Sistemi /Door Opening System  
90° Otomatik Dairesel Açma /90° Door Opening Device

Konstrüksiyon Kaplaması /Construction Coating  
Kompozit - Cam /Composite - Glass

Kuyu Dibi /Pit  
120mm

Voltaj /Voltage  
220V - 380V

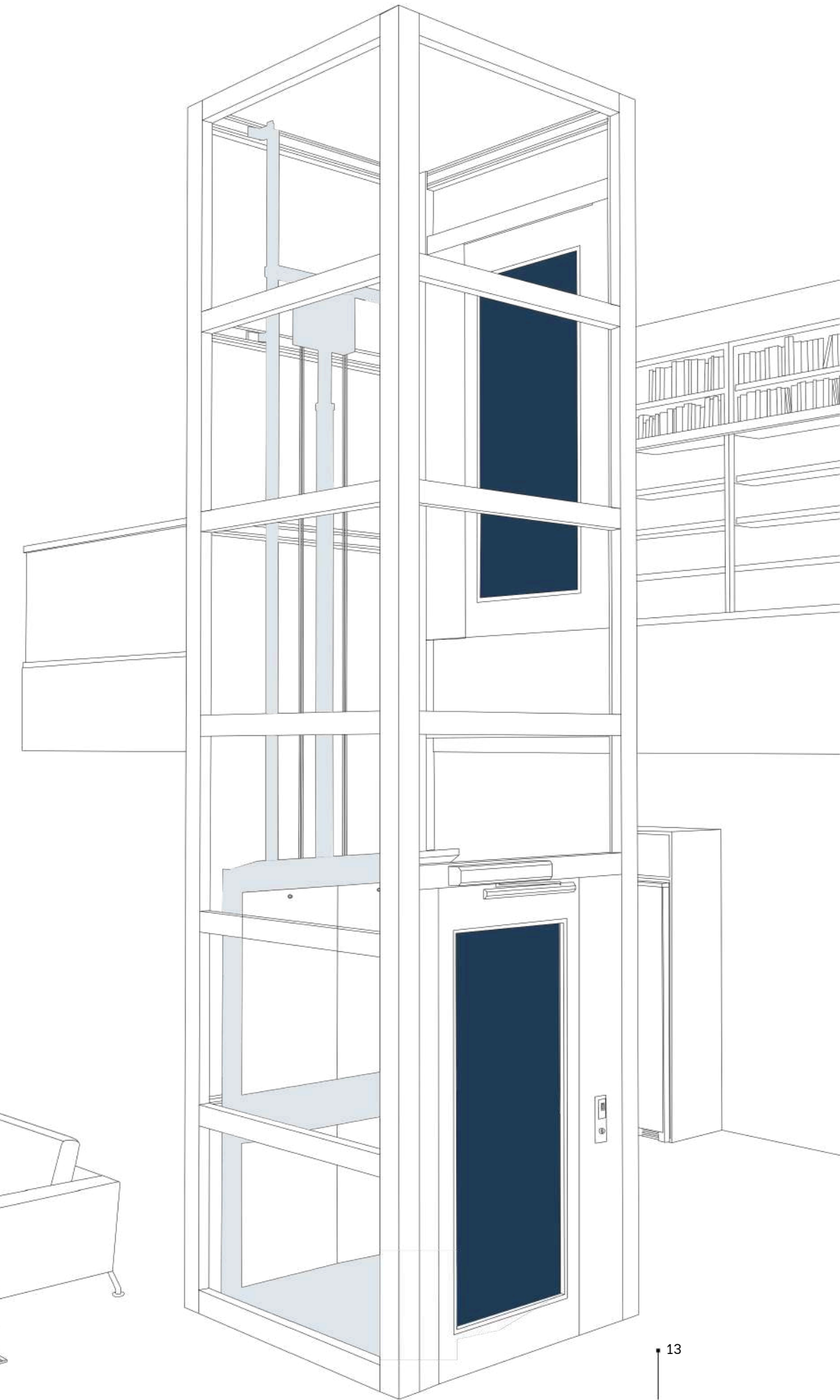
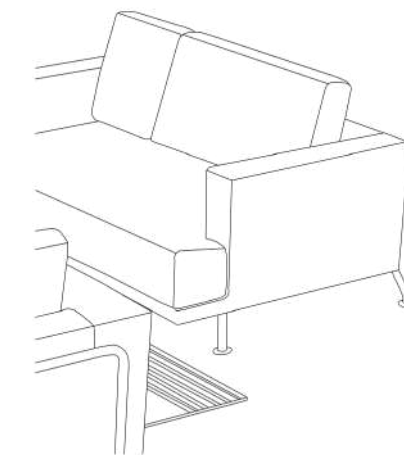

*Freedom to Move*

# KV 400



## SONSUZ VIDALI TIP ENGELLI PLATFORMU

WORM SCREW TYPE DISABLED PLATFORM

Yenilikçi tasarımı ve güçlü vidalı tahrik sistemiyle KV 400, hareket kısıtlılığı olan bireylerin yaşam alanlarında bağımsız ve güvenli erişim sağlaması için geliştirilmiştir.

*With its innovative design and powerful worm screw drive system, the KV 400 has been developed to provide independent and safe access to living spaces for people with reduced mobility.*



KV400, dış mekanlarda güvenliği, verimliliği ve dayanıklılığı bir arada sunan modern bir vidalı engelli platformudur. Kamu binaları ve okullar tarafından tercih edilir. Özellikle zorlu hava koşullarında mükemmel performans sergiler.

*The KV400 is a modern screw disabled platform that combines safety, efficiency and durability for outdoor use. It is preferred by public buildings and schools. It exhibits excellent performance especially in challenging weather conditions.*



Detaylı  
Ürün Bilgisi için  
Dokunun  
Touch for  
Detailed Product  
Information





# KV400 ZORLU KOŞULLARIN GÜÇLÜ ÇÖZÜMÜ

KV400  
POWERFUL SOLUTION FOR  
CHALLENGING CONDITIONS

Dış Mekana Tam Uyum  
Zorlu Hava Koşullarına Karşı Dayanıklı  
Sessiz ve Güvenli Çalışma  
Düşük Enerji Tüketimi  
Minimum Bakım İhtiyacı  
Uzun Ömürlü Kullanım

*Full Outdoor Adaptability  
Resistant Against Challenging Weather Conditions  
Quiet and Safe Operation  
Low Energy Consumption  
Minimum Maintenance Requirement  
Long-Lasting Use*

KV 400



KV 400

# GÜVENLİ ERİŞİM SESSİZ KONFOR

## SECUREACCESS, QUIETCOMFORT

KV400, hem iç hem de dış mekanlara uyum sağlayan, güçlü bir erişim çözümdür. Sonsuz vidalı tahrik sistemiyle sessiz ve titreşimsiz çalışırken, geniş platform alanı ve otomatik kapı açılımı sayesinde günlük kullanımda maksimum rahatlık sunar. Farklı renk seçenekleriyle her ortama estetik uyum sağlar.

*The KV 400 is an easy access solution that adapts to both indoor and outdoor environments. It offers maximum comfort in daily usage thanks to its large platform area and automatic door opening, while working silently and vibration-free with its worm screw drive system. That adapts aesthetically to every environment with different color options.*

### KONSTRÜKSİYON RENGİ CONSTRUCTION COLOR



## KV 400 Teknik Özellikler Technical Features

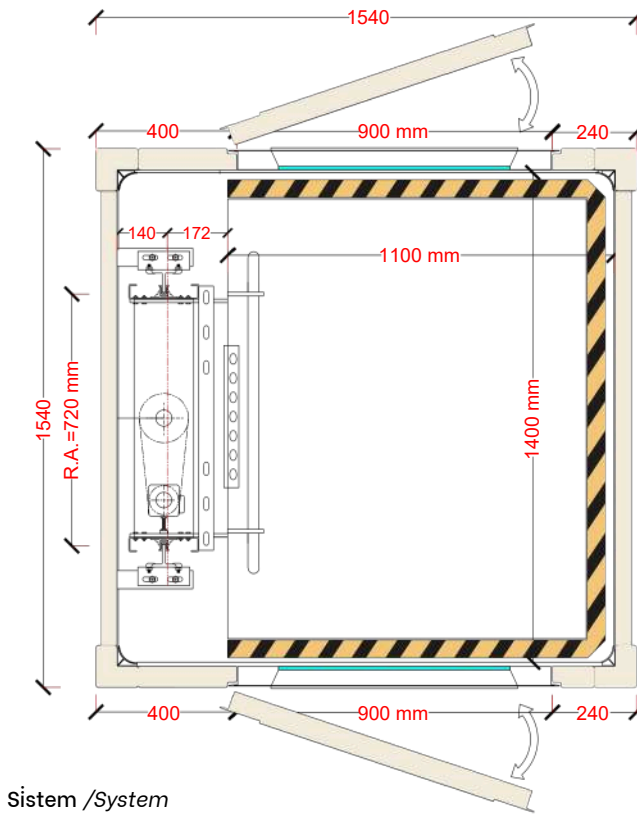

Sistem /System  
Vidalı /Screw And Nut

Hız /Speed  
Max. 0,15 m/s

Taşıma Kapasitesi /Carrying Capacity  
385 Kg

Durak Sayısı /Stops  
Max. 5 Durak /Max. 5 Stops

Max Seyir Mesafesi /Max Travel Distance  
13000mm

Çelik Konstrüksiyon Ölçüsü /Construction External Dimension  
1540x1540mm

Kullanım Yeri /Place of Use  
Dış - İç Mekan /Outdoor-Indoor

Platform Ölçüsü /Platform Dimension  
1100x1400mm

Kapı Ölçüsü /Door Dimension  
900x2000mm

Kapı Açma Sistemi /Door Opening System  
90° Otomatik Dairesel Açma /90° Door Opening Device

Konstrüksiyon Kaplaması /Construction Coating  
Kompozit - Cam /Composite - Glass

Kuyu Dibi /Pit  
120mm

Voltaj /Voltage  
220V





*Yeşilin İçinde Engelsiz Bir Yol*

An Unobstructed Road in Green

# VV 250



## HOMELIFT

VV 250 Kabinli Hidrolik Engelli Platformu, iç ve dış mekanlarda kullanım için özel olarak geliştirilmiş, modern tasarımı ve üstün teknik özellikleriyle öne çıkan bir erişim çözümüdür.

*VV 250 Cabin Hydraulic Disabled Platform is an access solution specially developed for indoor and outdoor use and stands out with its modern design and superior technical features.*



Estetik görünüm ile yüksek güvenliği bir araya getiren VV250 villalar ve özel konutlar için ideal bir çözüm sunar.

*Combining aesthetic appearance with high security, VV250 offers an ideal solution especially for offers an ideal solution for villas and private residences.*



Şık aydınlatma tasarımı ile evinize değer katar.

*It adds value to your home with modern lighting design.*

Detaylı  
Ürün Bilgisi için  
Dokunun  
Touch for  
Detailed Product  
Information



# MODERN VE ESTETİK TASARIM SEÇENEKLERİ

MODERN ANDAESTHETIC  
DESIGN OPTIONS

Vini VV250 modeliyle sizleredaha güvenli birçözümünmaktadır. Dekoratif kabin seçenekleri ve farklı konstrüksiyon renkleri ile yaşam alanlarınıza değer katar.

*Vini VV 250 offers you a safer solution with its model. It adds value to your living spaces with its decorative cabin options and different construction colors.*

VV 250

# AVANTAJLARI

## ADVANTAGES

- İçerideki mekan uyumlu modern tasarım.
- Kabinli sistem ile daha güvenli ve konforlu kullanım.
- Panoramik cam ve satine paslanmaz kabin alternatifleri.
- Mevcut alan ölçüsüne uygun özel üretim seçeneği.
- Farklı hız seçenekleri.
- Dayanıklı ve uzun ömürlü çelik konstrüksiyon.
- Estetik ve sağlam kompozit veya cam kaplama seçenekleri.

- Modern design in suitable with indoor and outdoor.
- Safer and more comfortable use with cabin system.
- Panoramic glass and satin stainless steel cabin alternatives.
- Special production option suitable for the available area size.
- With different speed options.
- Durable and long-lasting steel construction.
- Aesthetic and robust composite or glass coating options.

### KABIN TAVAN MODELLERİ

#### CABIN CEILING MODELS



Vini-001



Vini-002



Vini-003



Vini-004



Vini-005

### KABIN TABAN (PVC) MODELLERİ

#### CABIN FLOOR (PVC) MODELS

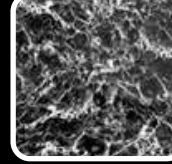

Siyah Mermer  
Black Marble



Çakıl Taşı  
Pebble Stone



Beyaz Mermer  
White Marble



Dokulu Halı  
Textured Carpet



Simli Halı  
Silvery Carpet

### KONSTRÜKSİYON RENGİ

#### CONSTRUCTION COLOR

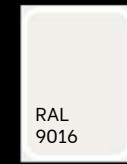

RAL  
9016



RAL  
1013



RAL  
7016



RAL  
1019

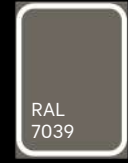

RAL  
7039



RAL  
9005

# VV 250

## Teknik Özellikler

### Technical Features

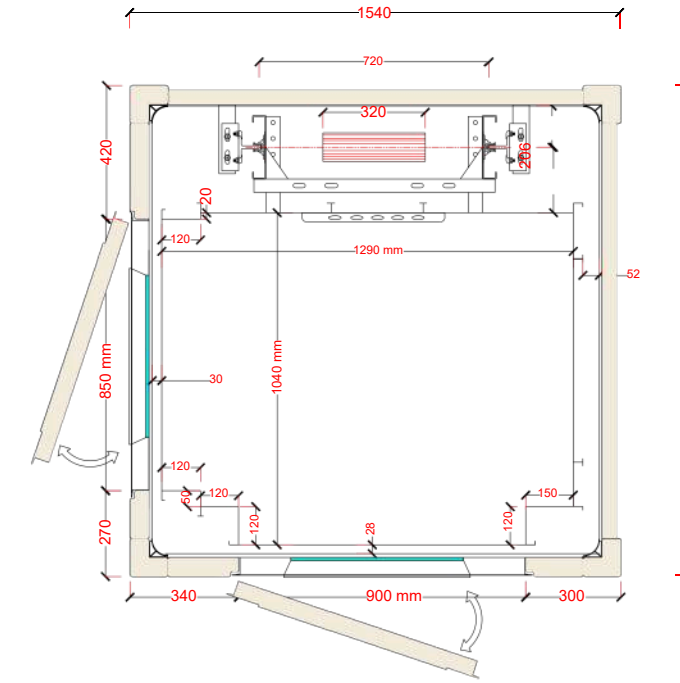

Sistem /System  
Hidrolik /Hydraulic

Hız /Speed  
Max. 0,15 m/s

Taşıma Kapasitesi /Carrying Capacity  
315 Kg

Durak Sayısı /Stops  
Max. 5 Durak /Max. 5 Stops

Max Seyir Mesafesi /Max Travel Distance  
13000mm

Çelik Konstrüksiyon Ölçüsü /Construction External Dimension  
1540x1540mm

Kullanım Yeri /Place of Use  
Dış - İç Mekan /Outdoor-Indoor

Platform Ölçüsü /Platform Dimension  
1290x1040mm

Kapı Ölçüsü /Door Dimension  
900x2000mm

Kapı Açma Sistemi /Door Opening System  
90° Otomatik Dairesel Açma /90° Door Opening Device

Konstrüksiyon Kaplaması /Construction Coating  
Kompozit - Cam /Composite - Glass

Kuyu Dibi /Pit  
200mm

Voltaj /Voltage  
220V - 380V

VV 250

*Hayatı Kat Kat Kolaylaştırıyoruz.*  
We make life easier many times over.

# VV 250 S



## TELESKOPIK KAPILI HOMELIFT

HOMELIFT WITH TELESCOPIC DOOR

VV 250 S, iç ve dış mekanlar için özel olarak tasarlanmış hidrolik platform sistemidir. Modern yapılarla uyum sağlayan bu asansör, bireysel kullanıcılar için güvenli, estetik ve verimli bir çözüm sunar.

*VV 250 S is a hydraulic platform system specially designed for indoor and outdoor use. Suitable in with modern structures, this elevator offers a safe, aesthetic and efficient solution for individual users.*



VV 250 S'in Teleskopik kapı özelliği, kullanımı kolaylaştırarak her türlü bina içi ve dış erişimi pratik hale getirir.

*The telescopic door feature of the VV 250 S makes it easy to operate, making any indoor and outdoor access practical.*



Teleskopik kapı, genişletilmiş alan, kolay geçiş.  
*Telescopic door, extended space, easy passage.*

Detaylı  
Ürün Bilgisi için  
Dokununuz

Touch for  
Detailed Product  
Information



ALWAYS WITH YOU  
ON EVERY FLOOR

VV 250 S

#### Her Yapıya Uyumlu

İç ve dış mekânlara özel tasarlanan VV 250 S, cam veya kompozit kaplama seçenekleri ile bulunduğu ortama değer katar. Geniş platform ölçüsü ve 5 duruşa kadar ulaşabilen yapıyla birçok projede güvenle kullanılabilir.

#### Suitable for Every Structure

Specially designed for indoor and outdoor spaces, VV 250 S adds value to its environment with glass or composite coating options. It can be used safely in many projects with its wide platform size and structure that can reach up to 5 stops.

#### Alan Kazandıran ve Güvenle Taşıyan

Teleskopik kapı ile şık bir tasarım, konforlu bir kullanım sunar.

#### Space Saving, Safe Carrying

The telescopic door offers a modern design and comfortable use.

# KULLANIM ALAN LARI

## AREAS OF USE

- Villalar • Müstakil Evler • Ofisler • Ticari Yapılar
- Villas
- Detached Houses
- Offices
- Commercial Buildings

VV 250 S

### KABIN TAVAN MODELLERİ CABIN CEILING MODELS



Vini-001



Vini-002



Vini-003



Vini-004



Vini-005

### KABIN TABAN (PVC) MODELLERİ CABIN FLOOR (PVC) MODELS

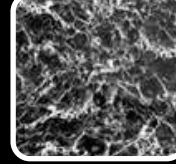

Siyah Mermer  
Black Marble



Çakıl Taşı  
Pebble Stone



Beyaz Mermer  
White Marble



Dokulu Halı  
Textured Carpet



Simli Halı  
Silvery Carpet

### KONSTRÜKSİYON RENGİ CONSTRUCTION COLOR



## VV 250 S Teknik Özellikler Technical Features

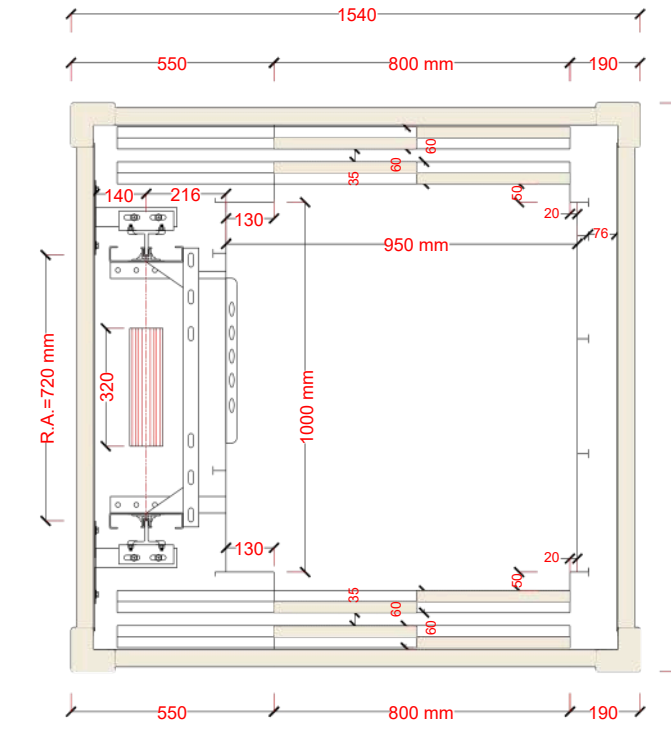

- Sistem /System  
Hidrolik /Hydraulic
- Hiz /Speed  
Max. 0,15 m/s
- Taşıma Kapasitesi /Carrying Capacity  
315 Kg
- Durak Sayısı /Stops  
Max. 5 Durak /Max. 5 Stops
- Max Seyir Mesafesi /Max Travel Distance  
13000mm
- Çelik Konstrüksiyon Ölçüsü /Construction External Dimension  
1540x1540mm
- Kullanım Yeri /Place of Use  
Dış - İç Mekan /Outdoor-Indoor
- Platform Ölçüsü /Platform Dimension  
950x1000mm
- Kapı Ölçüsü /Door Dimension  
800x2000mm
- Kapı Açma Sistemi /Door Opening System  
Teleskopik /Telescopic - Sliding Door
- Konstrüksiyon Kaplaması /Construction Coating  
Kompozit - Cam /Composite - Glass
- Kuyu Dibi /Pit  
200mm
- Voltaj /Voltage  
220V - 380V



# VB 250



## BETON KUYULU HOMELIFT

HOMELIFT WITH CONCRETE STRUCTURE

VB250 modeli, engelli olan ve olmayan bireylerin *The VB250 model is designed for safe access for* güvenli erişimi için tasarlanmıştır. Bu modelin en *people with and without disabilities. The most obvious* belirgin farkı, taşıyıcı yapısının çelik konstrüksiyon *difference of this model is that its carrying structure is* yerine mevcut beton kuyu içinde uygulanmasıdır.*implemented in an existing concrete shaft instead of a steel construction.*



VB250, estetikten ödün vermeden, daha sağlam ve uzun ömürlü bir çözüm arayan projeler için ideal bir tercihtir.

*VB250 is an ideal choice for projects looking for a more durable and long-lasting solution without compromising on aesthetics.*



Beton kuyu ile güçlü yapı, güvenli erişim.  
*Strong structure with concrete well, safe access.*

Detaylı  
Ürün Bilgisi için  
Dokunun  
*Touch for  
Detailed Product  
Information*

# İÇ MEKANA ÖZGÜ ŞİK VE MODERN TASARIM

INTERIORELEGANCE AND  
MODERN DESIGN

Betonkuyuyapısı,ekstradayanıklılık vesessiz çalışmımkansınar.  
Busayedepattformuzun ömürlüve güvenlidir.  
The concrete shaft structure offers extra durability and quiet operation.  
So the platform is long-lasting and safe.

VB 250

# AVANTAJLARI

## ADVANTAGES

- Dayanıklılık
- Sessiz çalışma
- Estetik vemişarım
- Kolay kurulum
- Güvenlik
- Durability
- Quiet operation
- Aesthetic and architectural design
- Easy installation
- Security

VB 250

### KABIN TAVAN MODELLERİ

#### CABIN CEILING MODELS



Vini-001



Vini-002



Vini-003



Vini-004



Vini-005

### KABIN TABAN (PVC) MODELLERİ

#### CABIN FLOOR (PVC) MODELS

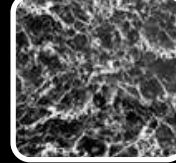

Siyah Mermer  
Black Marble



Çakıl Taşı  
Pebble Stone



Beyaz Mermer  
White Marble



Dokulu Halı  
Textured Carpet



Simli Halı  
Silvery Carpet

### KONSTRÜKSİYON RENGİ

#### CONSTRUCTION COLOR



RAL  
9016



RAL  
1013



RAL  
7016



RAL  
1019

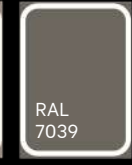

RAL  
7039



RAL  
9005

# VB 250

## Teknik Özellikler

### Technical Features

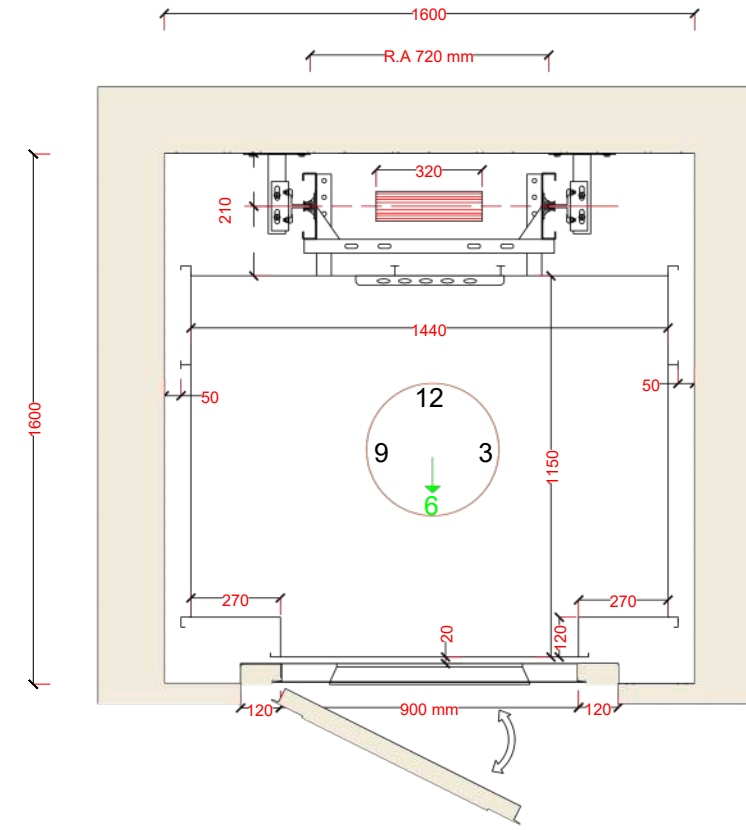

Sistem /System  
Hidrolik /Hydraulic

Hız /Speed  
Max. 0,15 m/s

Taşıma Kapasitesi /Carrying Capacity  
315 Kg

Durak Sayısı /Stops  
Max. 5 Durak /Max. 5 Stops

Max Seyir Mesafesi /Max Travel Distance  
13000mm

Beton Kuyu Ölçüsü /Concrete Scructre Dimension  
1600x1600mm

Kullanım Yeri /Place of Use  
İç Mekan /Indoor

Platform Ölçüsü /Platform Dimension  
1440x1150mm

Kapı Ölçüsü /Door Dimension  
900x2000mm

Kapı Açma Sistemi /Door Opening System  
90° Otomatik Dairesel Açma /90° Door Opening Device

Voltaj /Voltage  
220V-380V

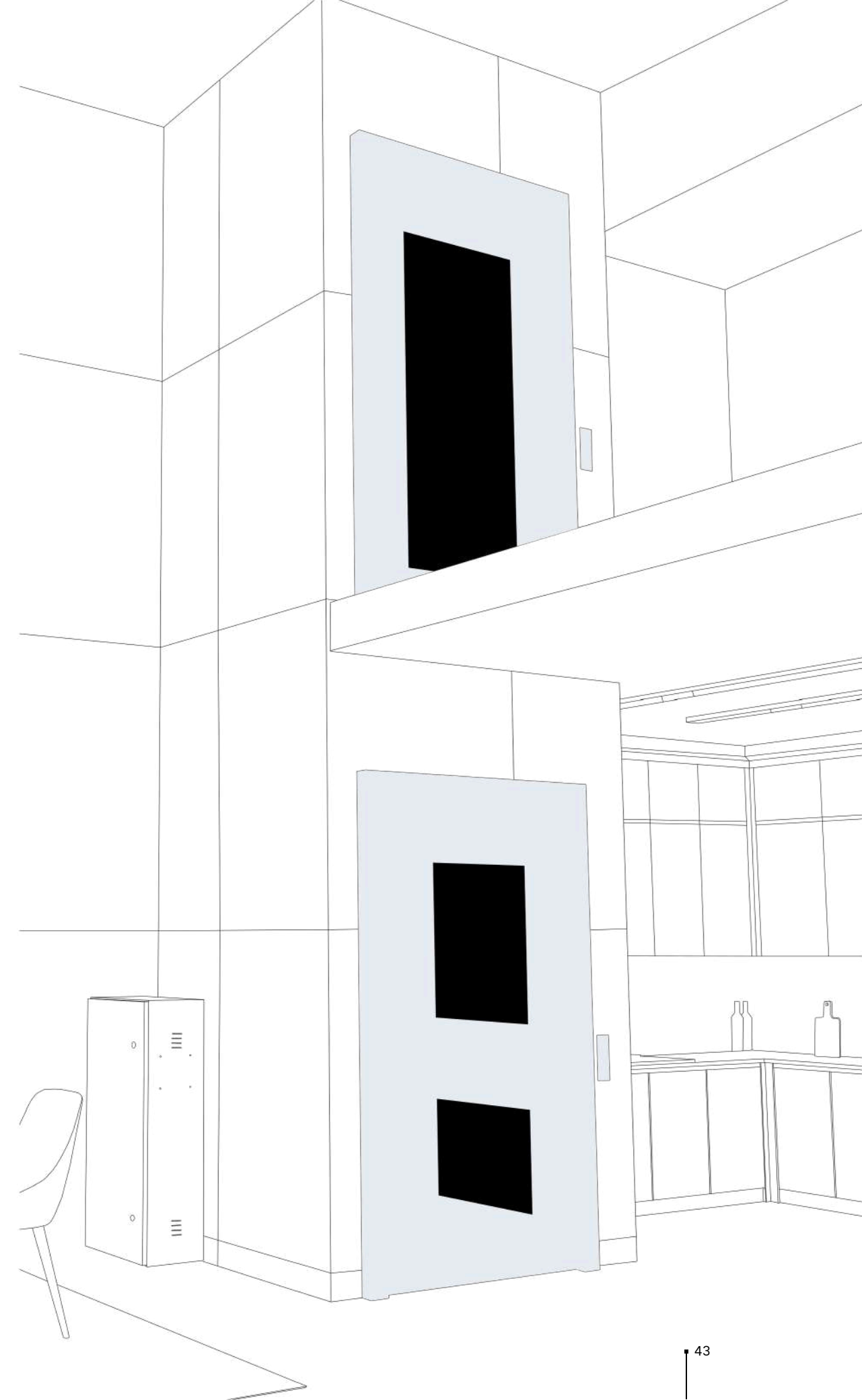

# VB 250 S



## BETON KUYULU TELESKOPIK KAPILI HOMELIFT

HOMELIFTWITHCONCRETE  
WELL TELESCOPICDOOR

VB 250 S tam otomatik teleskopik kapı sistemi ile alan kullanımını optimize ederken, kullanıcıların asansöre giriş ve çıkışını kolaylaştırır. Sağ ya da sol yöne açılabilen kapı seçenekleri ile kullanıcılara özel alternatif bir çözüm sunmaktadır.

*VB 250 S optimizes the use of space with its fully automatic telescopic door system, making it easier for users to enter and exit the elevator. It offers a special alternative solution for users with door options that can be opened in the right or left direction.*



315 kg taşıma kapasitesiyle bireysel kullanım için yeterli alan sunar. Farklı mimari ihtiyaçlara uyum sağlar ve projelere yüksek düzeyde tasarım esnekliği kazandırır.

*With its 315 kg carrying capacity, it offers enough space for individual use. It adapts to different architectural needs and brings a high level of design flexibility to projects.*



Detaylı  
Ürün Bilgisi için  
Dokunun  
Touch for  
Detailed Product  
Information





**ESTETİK VE SESSİZLİK**  
**BİR ARADA**  
AESTHETICS AND SILENCE  
COMBINED

VB 250 S

# YAŞAM ALANLARINIZA ERİŞİLEBİLİR KONFOR

## ACCESSIBLE COMFORT FOR YOUR LIVING SPACES

VB250S yalnızca bir asansör değil, aynı zamanda hayatı kolaylaştıran bir çözümdür. Engelli bireylerin erişimini güvenli ve konforlu hale getirirken; yaşlı kullanıcılar için de günlük yaşamda büyük bir kolaylık sunar.

The VB250 S is not only an elevator, but also a solution that makes life easier. While making access safe and comfortable for people with disabilities, it also offers great convenience in daily life for elderly users.

# VB 250 S

### KABIN TAVAN MODELLERİ CABIN CEILING MODELS



Vini-001



Vini-002



Vini-003



Vini-004



Vini-005

### KABIN TABAN (PVC) MODELLERİ CABIN FLOOR (PVC) MODELS

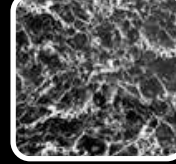

Siyah Mermer  
Black Marble



Çakıl Taşı  
Pebble Stone



Beyaz Mermer  
White Marble



Dokulu Halı  
Textured Carpet



Simli Halı  
Silvery Carpet

### KONSTRÜKSİYON RENGİ CONSTRUCTION COLOR

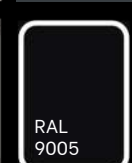
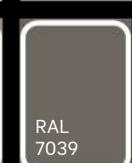

## VB 250 S Teknik Özellikler Technical Features

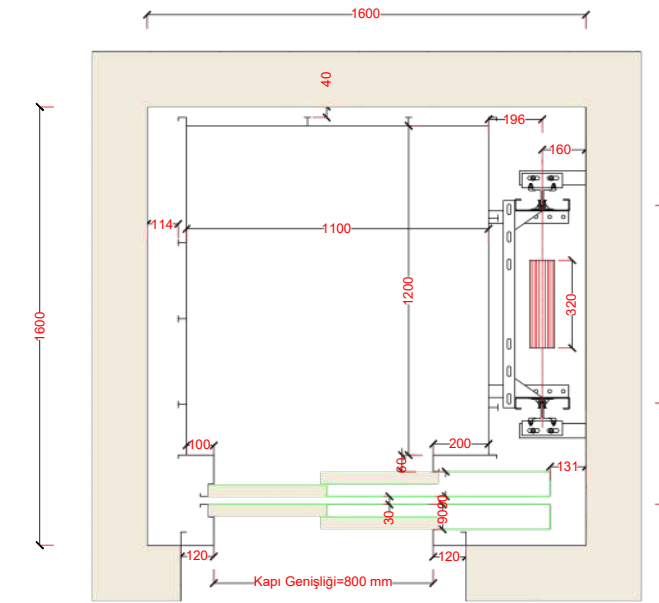

- Sistem /System  
Hidrolik /Hydraulic
- Hiz /Speed  
Max. 0,15 m/s
- Taşıma Kapasitesi /Carrying Capacity  
315 Kg
- Durak Sayısı /Stops  
Max. 5 Durak /Max. 5 Stops
- Max Seyir Mesafesi /Max Travel Distance  
13000mm
- Beton Kuyu Ölçüsü /Concrete Structure Dimension  
1600x1600mm
- Kullanım Yeri /Place of Use  
İç Mekan /Indoor
- Platform Ölçüsü /Platform Dimension  
1100x1200mm
- Kapı Ölçüsü /Door Dimension  
900x2000mm
- Kapı Açma Sistemi /Door Opening System  
Teleskopik /Telescopic - Sliding Door
- Voltaj /Voltage  
220V - 380V

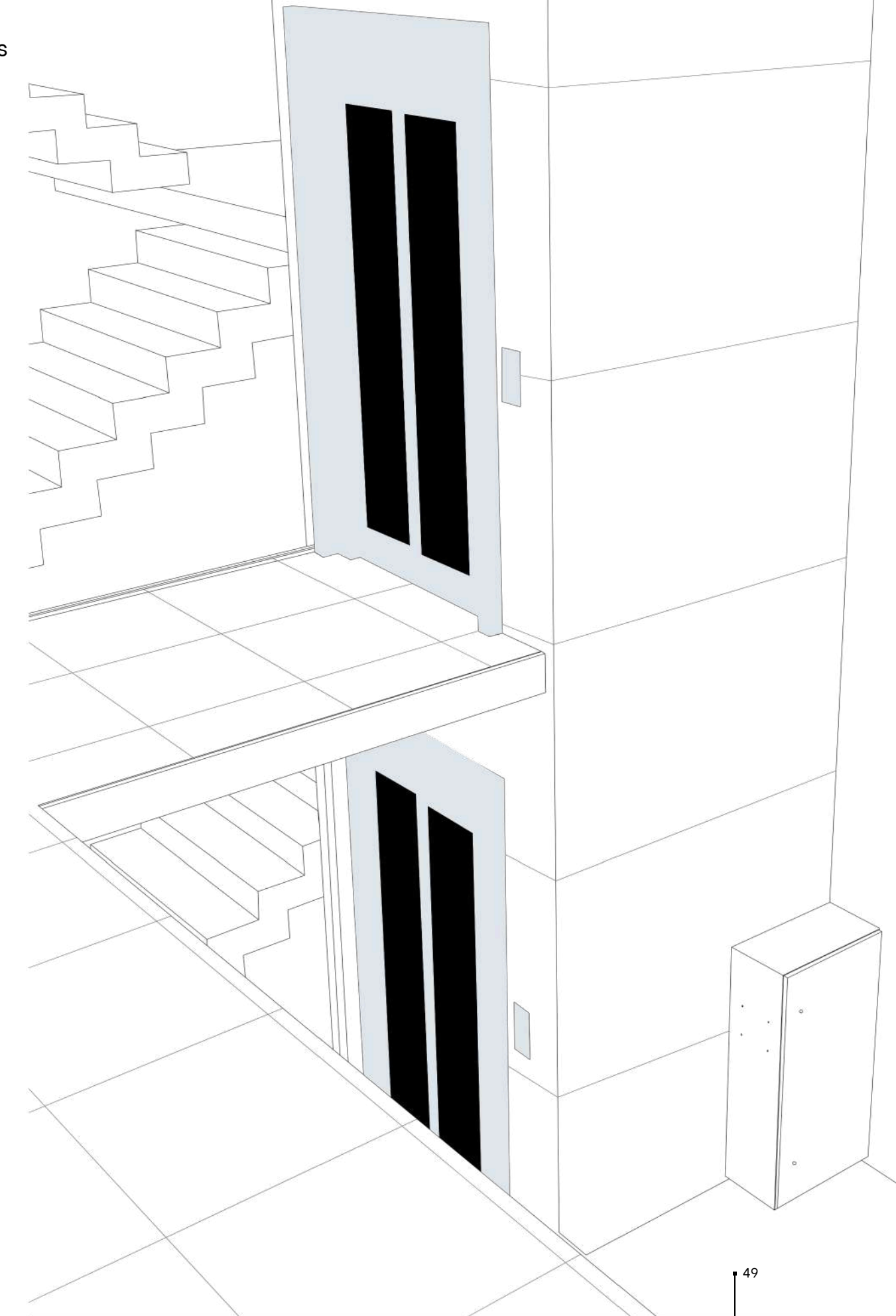

*Erişilebilirlik Herkesin Hakkı*  
Accessibility is Everyone's Right

# MN 180



## DUBLEX HOMELIFT

Tek kişilik kullanım kapasitesine sahip dar alanlar için tasarlanmış bir platformdur.

*It is a platform designed for narrow spaces with a single person capacity.*



Yüksek kaliteli vidalı tahrik sistemi ve güvenlik önlemleriyle donatılmış olan Mini Asansör, konforlu ve güvenli bir ulaşım sunar. Modern tasarımı ve kompakt yapısıyla her türlü iç mekan için uyum sağlar.

*Equipped with a high quality worm screw drive system and safety precautions, the Mini Elevator offers comfortable and safe transportation. With its modern design and compact structure, it adapts to any interior space.*



## MINIMUM ALAN MAKSİMUM PERFORMANS

MAXIMUM PERFORMANCE  
IN MINIMUM SPACE



Detaylı  
Ürün Bilgisi için  
Dokunun

Touch for  
Detailed Product  
Information



Estetik ve fonksiyonel yapısıyla, hem kullanım kolaylığı hemde yer tasarrufu sağlar.  
*With its aesthetic and functional structure, it provides both easy of use and space saving.*

# KÜÇÜK ALANLARDA BÜYÜK RAHATLIK

GREAT COMFORT  
IN SMALL SPACES

MN 180



# KOMPAKT TASARIM

COMPACT  
DESIGN

MN 180

## MN 180

Teknik Özellikler  
Technical Features

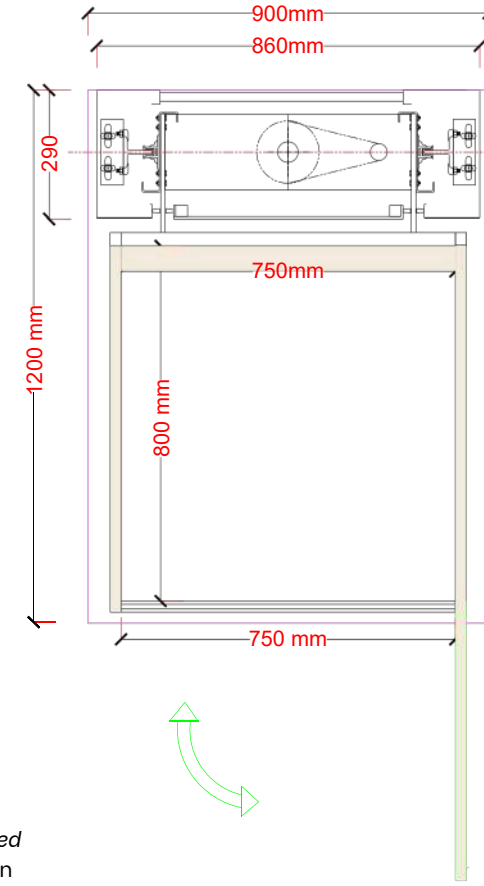

Hiz /Speed  
0,15 M/Sn

Kapasite /Capability  
180kg

Diş Ölçü /Outside Dimension  
900x1200mm

İç Ölçü /Inside Dimension  
750x800mm

Sistem /System

Vidalı /Screw and Nut

Durak Sayısı /Stops  
Max. 2 Durak /Max. 2 Stops

Max Seyir Mesafesi /Max Travel Distance  
3 mt

Kullanım Yeri /Place of Use  
İç Mekan /Indoor

Kapı Açma Sistemi /Door Opening System  
Manuel

Kuyu Dibi /Bottom of the Well  
120mm

Kapı Ölçüsü /Door Dimension  
750\*2000mm

Voltaj /Voltage  
220V



*Size Özel Çözümler.*  
Customized Solutions for You.

# AH 250-AV 250

HYDRAULIC OPEN TYPE PLATFORM

**SONSUZ VIDALI AÇIK TIP PLATFORM**

OPEN TYPE PLATFORM WITH WORM SCREWS



AH250 ve AV250 modelleri, kapalı tip platform sistemlerinin uygun olmadığı alanlar için geliştirilmiş, açık tip engelli platformlarıdır. Dış ve iç mekân kullanımına uygun tasarımı sayesinde konut girişleri, iş merkezleri, sosyal alanlar ve kamu kurumlarında erişilebilirlik ihtiyacını karşılamak üzere tasarlanmıştır.

*AH250 and AV250 models are open type disabled platforms developed for areas where closed type platform systems are not suitable. Thanks to its design suitable for outdoor and indoor use, it is designed to the accessibility needs of residential entrances, business centers, social areas and public institutions.*



**AH 250**  
Hidrolik sistemli açık tip engelli platformu.  
Open type disabled platform with hydraulic system

**AV 250**  
Sonsuzvidalı sistemli açık tip engelli platformu.  
Open type disabled platform with worm screw system.

Detaylı  
Ürün Bilgisi için  
Dokunun  
Touch for  
Detailed Product  
Information



# AÇIK TIP PLATFORMLARDA MAKSİMUM PERFORMANS

## MAXIMUM PERFORMANCE ONOPEN TYPE PLATFORMS

AV250 ve AH250 modelleri, farklı yükseklik seviyeleri için güvenli ve şık erişim çözümleri sunar. AV250, 3000 mm'ye kadar olan kot farkları için ideal bir tercihtir; AH250, 2000 mm'ye kadar sessiz ve sarsıntısız bir hareket avantajı sağlar. Her iki modelde de 250 kg taşıma kapasitesi, 90° otomatik dairesel kapı sistemi ve çelik konstrüksiyon standart olarak sunulur. Modern tasarımları sayesinde, buldukları yapıya hem işlevsellik hem de estetik kazandırır.

The AV250 and AH250 models offer safe and stylish access solutions for different height levels. The AV250 is the ideal choice for elevation differences up to 3000 mm, while the AH250 provides the advantage of quiet and smooth movement up to 2000 mm. Both models come standard with 250 kg payload capacity, 90° automatic circular door system and steel construction. Thanks to their modern design, they bring both functionality and aesthetics to the building they are located in.

AV 250

# AV 250-AH 250

## Teknik Özellikler Technical Features

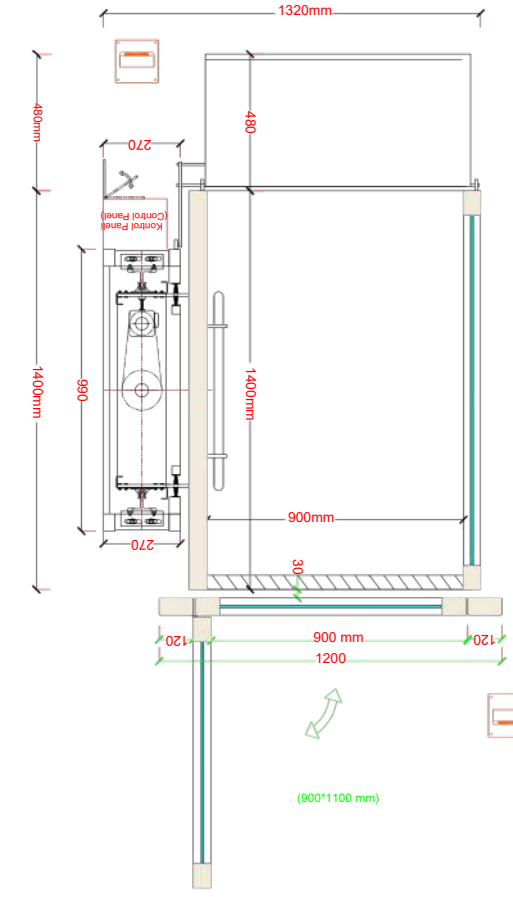

AV 250	AH 250
Sistem/System	Sistem /System
Vidalı /Screw	Hidrolik /Hydraulic
Hiz /Speed	
Max. 0,15 m/s	
Taşıma Kapasitesi /Carring Capacity	
250 Kg	
Durak Sayısı /Stops	
Max. 2 Durak /Max. 2 Stops	
Max Seyir Mesafesi /Max Travel Distance	
3000mm	
Çelik Konstrüksiyon Ölçüsü /Construction External Dimension	
1320x1400mm	
Kullanım Yeri/Place of Use	
Dış Mekan - İç Mekan /Outdoor - Indoor	
Platform Ölçüsü /Platform Dimension	
900x1400mm	
Kapı Ölçüsü /Door Dimension	
900x1100mm	
Kapı Açma Sistemi /Door Opening System	
90° Otomatik Dairesel Açma /90° Door Opening Device	
Voltaj /Voltage	
220V - 380V	

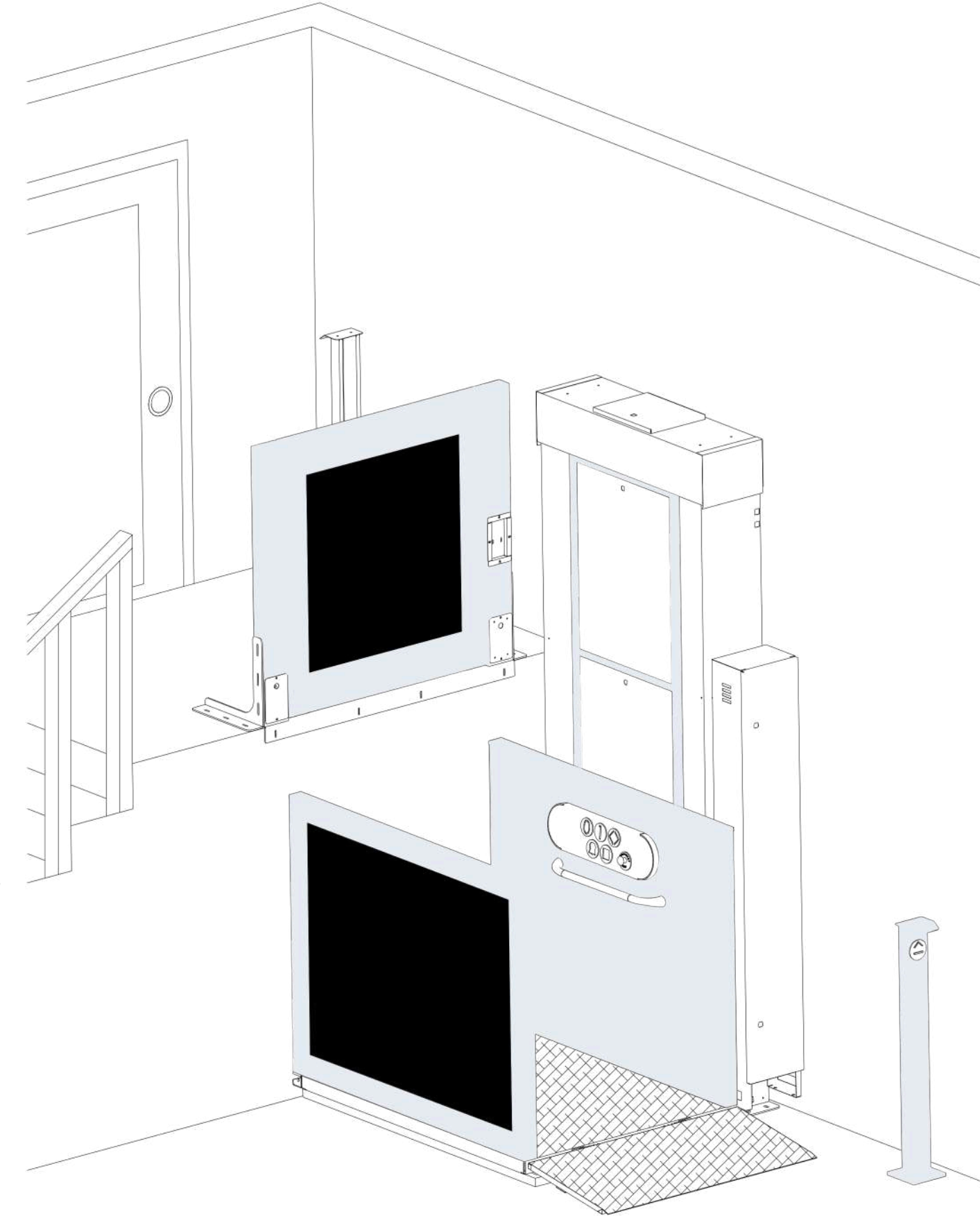

*Engelsiz geleceğe doğru, birlikte adım atalım.*  
Let's take a step together towards a future without barriers.

# DM 300

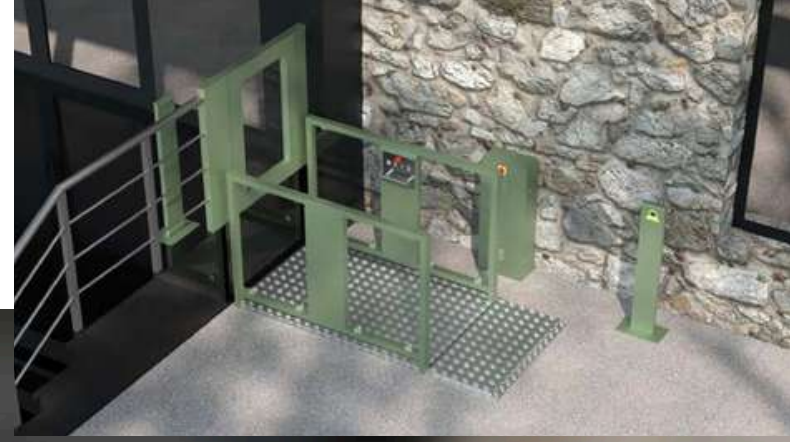

## MAKASLI TIP HIDROLİK ENGELLI PLATFORMU

SCISSOR TYPE HYDRAULIC  
DISABLED PLATFORM

Platform altında yer alan körüklü güvenlik sistemi, hareket halindeyken kullanıcı ve çevredeki diğer kişilerin güvenliğini sağlayarak, olası riskleri ortadan kaldırır. Bu sistem, platform altında yabancı cisim bulunması durumunda cihazın hareketini durdurur ve maksimum iş güvenliği standartlarına uygun çalışmasını sağlar.

*The bellows safety system under the platform eliminates possible risks by ensuring the safety of the user and other persons in the environment while moving. This system stops the movement of the device in case of foreign objects under the platform and ensures that it operates in accordance with maximum occupational safety standards.*

Hidrolik tahrik sistemi sayesinde sessiz, sarsıntısız ve güvenli bir çalışma performansı sunan DM300, aynı zamanda minimum bakım ihtiyacı ve uzun ömürlü kullanım avantajı sağlar.

*Thanks to its hydraulic drive system, the DM300 offers a quiet, smooth and safe working performance, while at the same time providing the advantage of minimum maintenance and long-lasting use.*

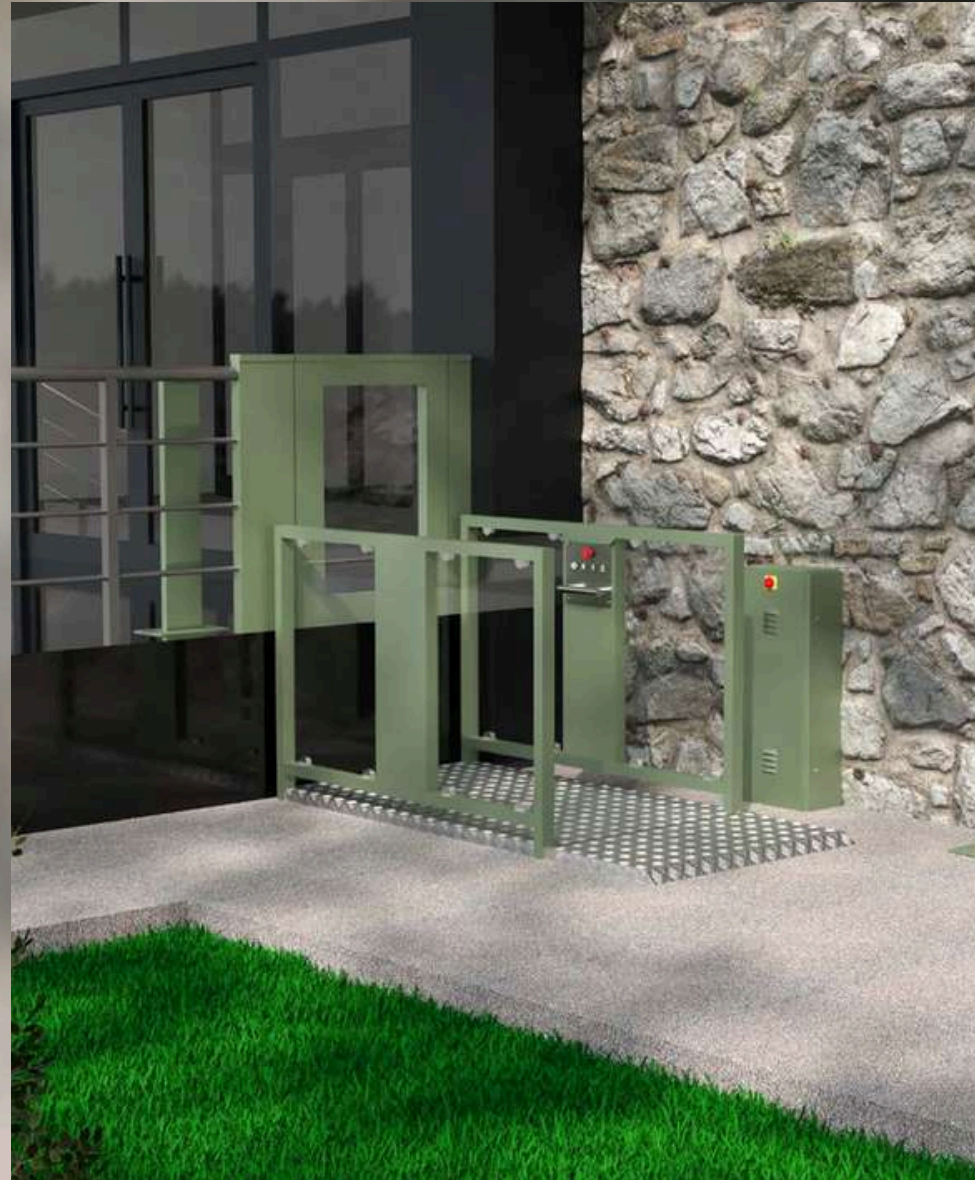

Detaylı  
Ürün Bilgisi için  
Dokunun  
Touch for  
Detailed Product  
Information



Dış ve iç mekan kullanımı için özel olarak tasarlanan DM300, kompakt ölçüleri ve estetik yapısıyla her türlü mimari projeye uyum sağlarken, yüksek taşıma kapasitesi ve kullanıcı dostu otomatik kapı sistemiyle maksimum konfor sunar.

*Specially designed for outdoor and indoor use, the DM300 adapts to any architectural project with its compact dimensions and aesthetic structure, while offering maximum comfort with its high carrying capacity and user-friendly automatic door system.*

## DM 300

## DM 300

### Teknik Özellikler Technical Features

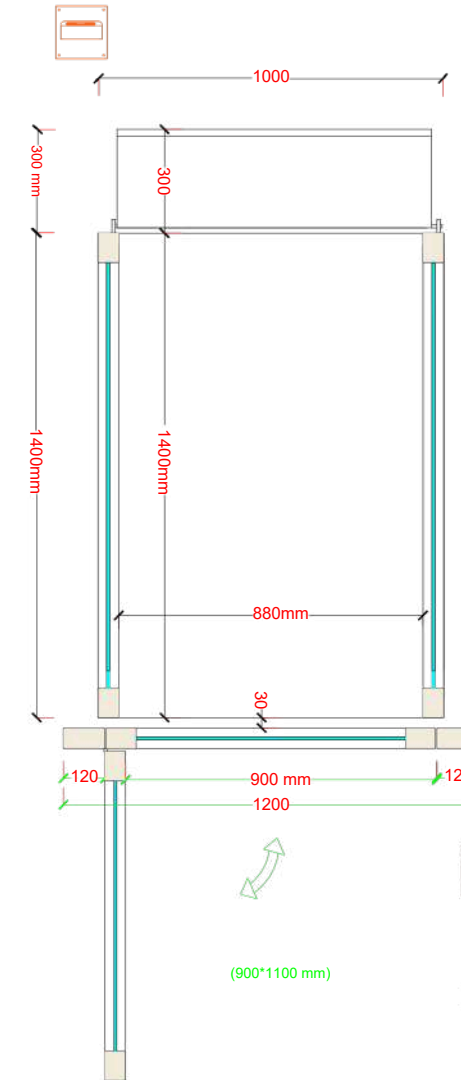

Sistem /System  
Hidrolik /Hydraulic

Hız /Speed  
Max. 0,15 m/s

Taşıma Kapasitesi /Carrying Capacity  
250 Kg

Durak Sayısı /Stops

Max. 2 Durak /Max. 2 Stops

Max Seyir Mesafesi /Max Travel Distance  
1000mm

Voltaj /Voltage  
220V - 380V

Kullanım Yeri /Place of Use  
Dış Mekan - İç Mekan /Outdoor - Indoor

Platform İç Ölçüsü /Platform Inside Dimension  
880x1400mm

Platform Dış Ölçüsü /Platform Outside Dimension  
1000x1400mm

Kapı Ölçüsü /Door Dimension

900x1100mm

Kapı Açma Sistemi /Door Opening System

90° Otomatik Dairesel Açma /90° Door Opening Device

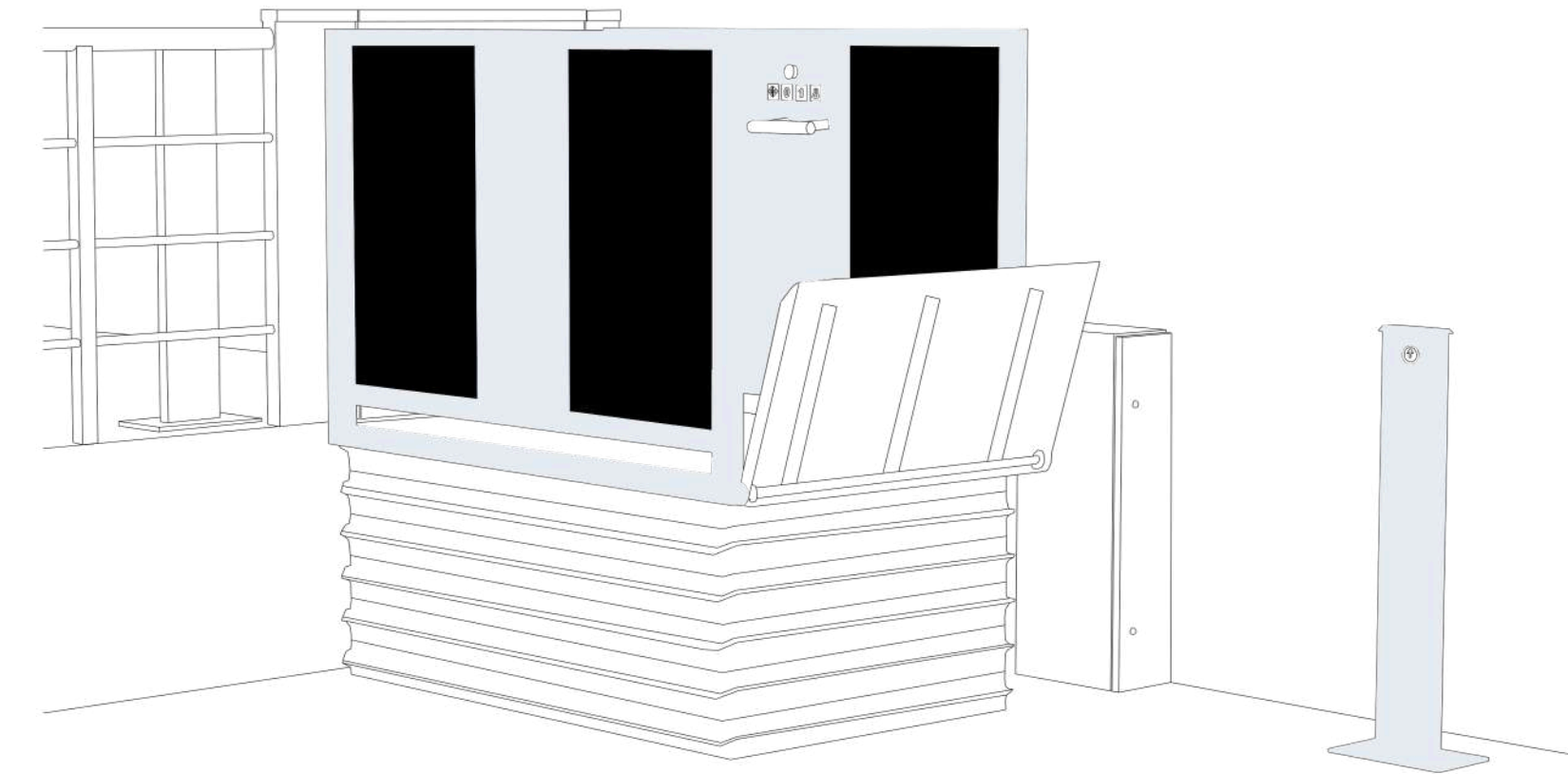

# CK 800



## MODÜLER ÇELİK KUYU MODULAR STEEL WELL

CK 800, maksimum 1000 kg taşıma kapasitesi ve 1.6 m/sn hızıyla yüksek performans gerektiren projeler için tasarlanmış sağlam bir asansör kuyusudur. Ölçüye özel proje desteği sayesinde farklı mimari ihtiyaçlara kolayca adapte olurken, istenilen ölçüde kuyu dibi mesafesi ve son kat yüksekliğiyle tam uyum sağlar.

*CK 800 is a durable elevator shaft designed for projects requiring high performance with a maximum carrying capacity of 1000 kg and a speed of 1.6 m/sec. Thanks to its size-specific project support, it easily adapts to different architectural needs, while fully complying with the desired shaft bottom distance and top floor height.*



Kolay kurulum ve kaplama özellikleriyle montaj sürecini hızlandıran CK 800, kullanıcıya isteğe bağlı renk seçeneği sunarak estetik bütünlüğü destekler.

*CK 800, which accelerates the assembly process with its easy installation and coating features, supports aesthetic integrity by offering the user an optional colour option.*



Detaylı  
Ürün Bilgisi için  
Dokunun  
Touch for  
Detailed Product  
Information



# CK 800

## Teknik Özellikler Technical Features

### Taşıma Kapasitesi Loading Capacity

A B C  
400-630-800 kg

### Kabin Ölçüleri Cabin Dimensions

Genişlik  
Width 1000-1100-1320 mm  
Derinlik  
Depth 1100-1400-1400 mm

### Kapı Ölçüleri Door Dimensions

Genişlik  
Width 700-800-900 mm  
Yükseklik  
Height 2000-2000-2000 mm

### Kuyu Ölçüleri Shaft Dimensions

Genişlik  
Width 1800-1900-2150 mm  
Derinlik  
Depth 1600-1900-1900 mm

1000 Kg 1.6 M/sn hız dayanıklı  
Can be used up to speed of 1.6 m/s

Kolay kurulum, kolay kaplama  
Easy installation and covering

Ölçüye özel proje  
Special projects with special dimensions

İsteğe bağlı renk seçeneği  
Colour options

İstenilen ölçüde kuyu dibi mesafesi ve son kat yüksekliği  
The desired well distance and last floor height

Kuyu bağlı makine sehpa ve halat bağlama sacı  
Fixed machine frame and rope tying sheet

Sacdan çelik konstrüksiyon direkleri ve yatay bölmeleri  
Steel construction column and horizontal compartment

## MODULAR SHAFT

CK 800

# YT 225



## MERDİVENLER ENGELDEĞİL, GEÇİŞ NOKTASI

CHAIR TYPE  
DISABLED PLATFORM

Daralanları için özel olarak geliştirilen YT225 Merdiven Platformları, hareket kabiliyeti sınırlı bireylerin zorluk yaşamadan her kata erişebilmesini sağlar. Katlanabilir yapısı sayesinde yer kaplamaz, kullanımı kolay ve son derece güvenlidir.

*Specially developed for narrow spaces, YT225 Stair Platforms allow individuals with limited mobility to access every floor without difficulty. Thanks to its foldable structure, it does not take up space, is easy to use and extremely safe.*



## YT 225

Teknik Özellikler  
Technical Features

Hız /Speed  
Max. 0,15 m/s

Taşıma Kapasitesi /Carring Capacity  
225 Kg

Platform Ölçüleri /Platform Dimension  
800x1000 - 1200x1000 - 800x850 - 700x850

Kullanım Yeri /Place of Use  
Dış Mekan - İç Mekan /Outdoor - Indoor

Tırmanma /Climbing  
45°'ye Kadar Tırmanma /Climbing up to 45°

Kumanda Şekli /Controller Type  
Duraklarda Kablosuz, Su Geçirmez Uzaktan Kumanda  
/Wireless, Waterproof Remote Control at Stops

Detaylı  
Ürün Bilgisi için  
Dokunun  
Touch for  
Detailed Product  
Information



# KT 225

## KOLTUK TIPI ENGELLI PLATFORMU

CHAIR STAIRLIFTS TYPE PLATFORM

Teknik Özellikler

Technical Features

Hız /Speed  
Max.0,15m/s

Taşıma Kapasitesi /Carring Capacity  
125 Kg

Oturma Geniřliđi/Seating-Width  
585mm

Kullanım Yeri/PlaceofUse  
İç Mekan /Indoor

Maksimum Çıkış Açısı /Maximum Output Angle  
-90° ila +90° arası meyiller /Slopes from -90° to +90°

Seyahat Mesafesi /Travelling Distance  
Maximum34 m

Çalışma Sistemi /Operation-System  
24 V akülü motor /24 V battery motor

Elektrik Bağlantısı /Electrical Connection  
1 faz 230V 50 Hz /1 phase 230V 50 Hz



Detaylı  
Ürün Bilgisi için  
Dokunun

Touch for  
Detailed Product  
Information



# HT 150

## HAVUZ TIPI ENGELLI PLATFORMU

POOL TYPE DISABLED PLATFORM

HT225 Havuz Tipi Engelli Platformu, yüzme havuzlarında engelli bireylerin suya güvenli ve konforlu bir şekilde giriş-çıkış yapabilmesi için özel olarak tasarlanmıştır. Modern tasarımı ve yüksek güvenlik standartlarıyla her türlü havuz ortamında kullanılabilir.

HT225 Pool Type Disabled Platform is specially designed for disabled people to enter and exit the water safely and comfortably in swimming pools. It can be used in any pool environment with its modern design and high safety standards.

Kolay kurulum  
Easy installation

Konfor  
Comfort

Özel uygulamalar  
Special applications

PRODUCT OF SUPPLY  
TEDARIK  
ÜRÜNÜDÜR

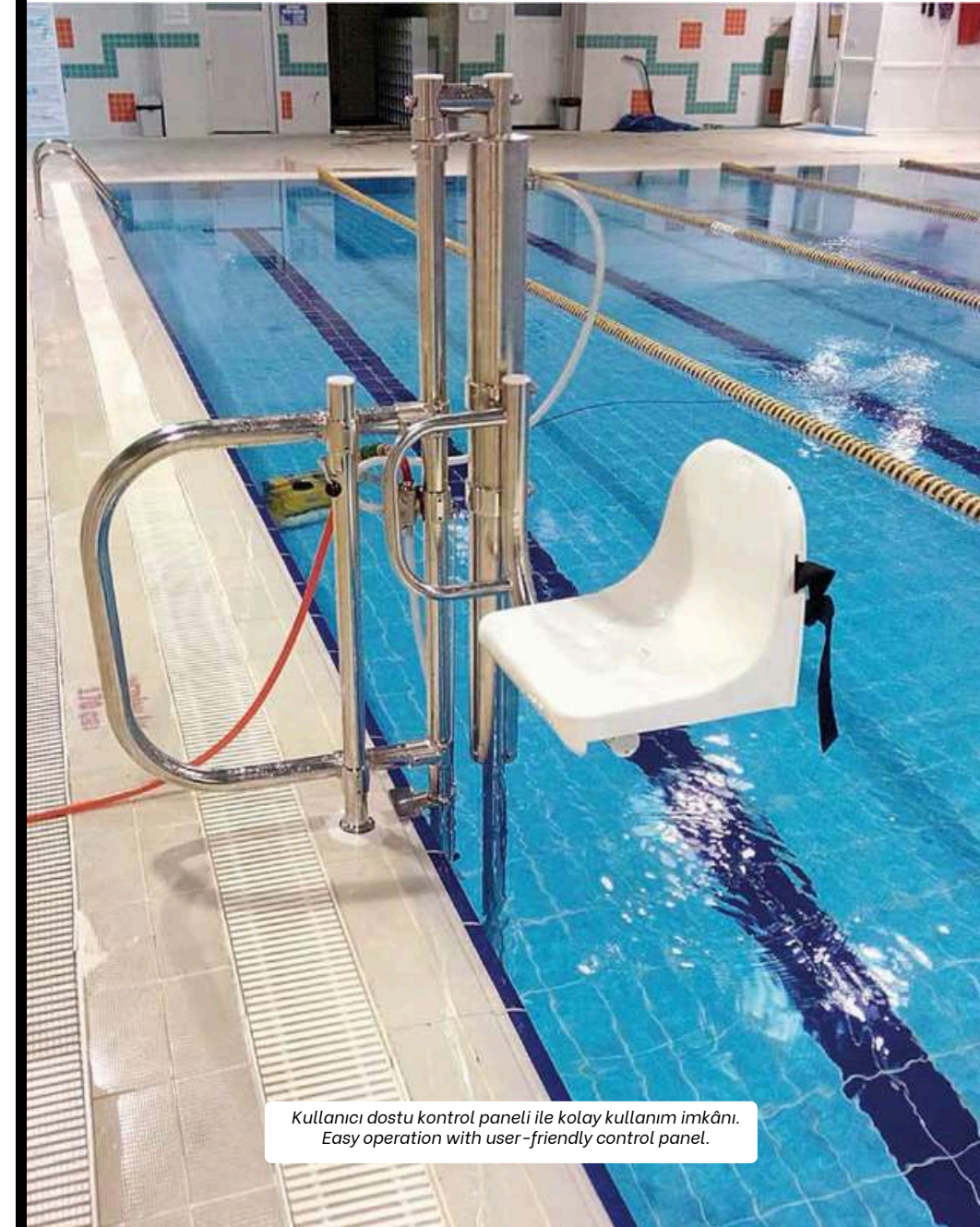

Kullanıcı dostu kontrol paneli ile kolay kullanım imkânı.  
Easy operation with user-friendly control panel.

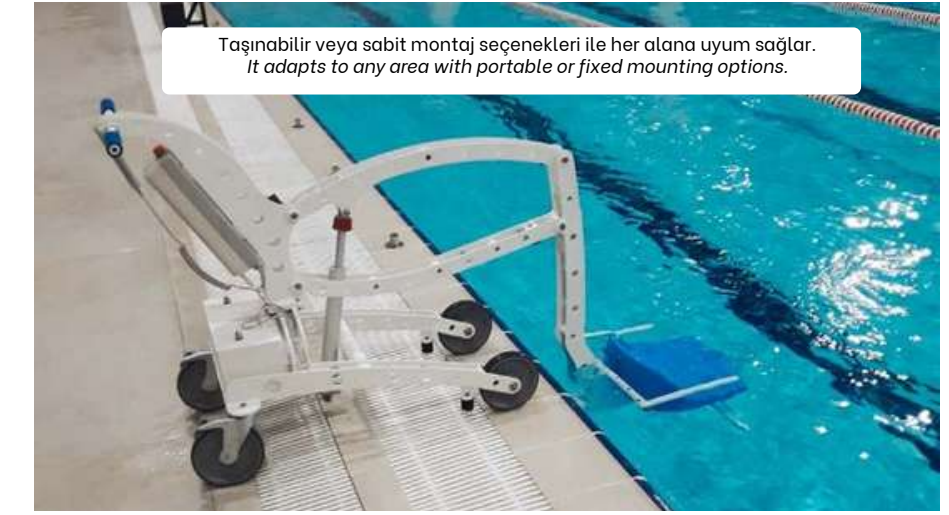

Taşıyabilir veya sabit montaj seçenekleri ile her alana uyum sağlar.  
It adapts to any area with portable or fixed mounting options.

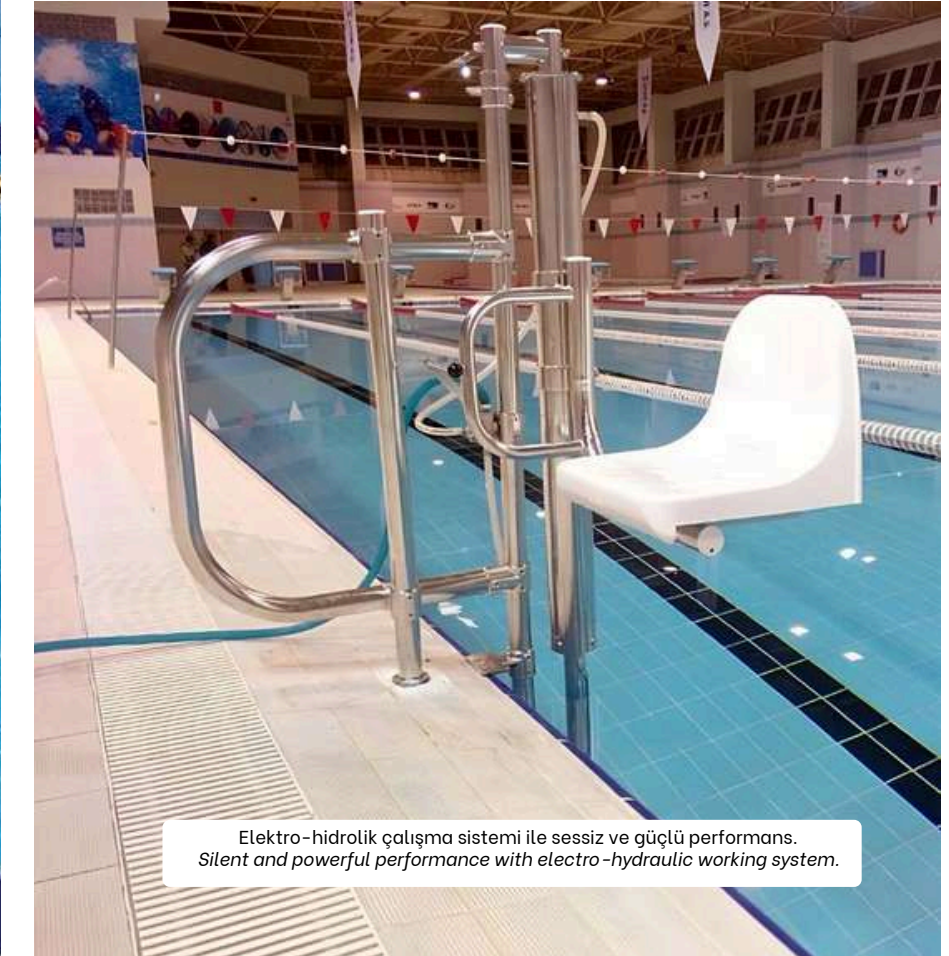

Elektro-hidrolik çalışma sistemi ile sessiz ve güçlü performans.  
Silent and powerful performance with electro-hydraulic working system.

# UYGULAMALARIMIZ

OUR ASSEMBLIES

40'DAN FAZLA ÜLKEYE İHRACAT

EXPORT TO MORE THAN 40 COUNTRIES

